

# Non-sparking Insulated Tools

L



MANUFACTURED  
ACCORDING TO  
**IEC60900**  
STANDARD

 1000V

**DIPPED**  
INSULATED  
TOOLS  
**INJECTION**  
INSULATED  
TOOLS

**No.6101 Injection Slotted Screwdriver**



Number	L <sub>1</sub> inch	L <sub>1</sub> mm	L mm	H mm	B mm	Be-Cu g	Al-Cu g
6101-1002	2	50	134	0.5	3	35	33
6101-1006	3	75	159	0.6	3	35	32
6101-1008	3	75	159	0.8	4	45	42
6101-1010	3	75	180	1.0	5	70	65
6101-1012	4	100	184	0.8	4	45	42
6101-1014	4	100	205	1.0	5	75	70
6101-1016	4	100	215	1.1	6	85	80
6101-1018	5	125	240	1.1	6	100	95
6101-1020	6	150	265	1.1	6	110	105
6101-1022	6	150	265	1.2	7	125	120
6101-1024	6	150	277	1.2	8	140	135
6101-1026	8	200	327	1.2	8	165	155
6101-1028	10	250	377	1.6	9	185	175

**No.6102 Injection Phillips Screwdriver**



Number	L <sub>1</sub> inch	size	L <sub>1</sub> mm	L mm	Φ mm	Be-Cu g	Al-Cu g
6102-1002	2	0	50	134	3	35	32
6102-1004	3	1	75	159	4	70	63
6102-1006	4	1	100	205	5	75	70
6102-1008	5	2	125	240	6	100	95
6102-1010	6	2	150	265	6	110	105
6102-1012	8	3	200	327	8	165	155
6102-1014	10	3	250	377	8	185	170

**No.6101A Injection Slotted Screwdriver**

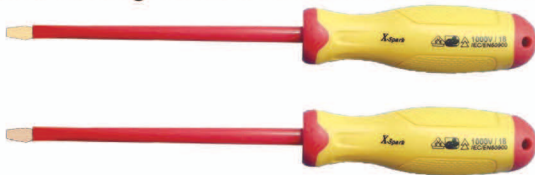

Number	L <sub>1</sub> inch	L <sub>1</sub> mm	L mm	H mm	B mm	Be-Cu g	Al-Cu g
6101A-1002	2	50	134	0.5	3	35	33
6101A-1006	3	75	159	0.6	3	35	32
6101A-1008	3	75	159	0.8	4	45	42
6101A-1010	3	75	180	1.0	5	70	65
6101A-1012	4	100	184	0.8	4	45	42
6101A-1014	4	100	205	1.0	5	75	70
6101A-1016	4	100	215	1.1	6	85	80
6101A-1018	5	125	240	1.1	6	100	95
6101A-1020	6	150	265	1.1	6	110	105
6101A-1022	6	150	265	1.2	7	125	120
6101A-1024	6	150	277	1.2	8	140	135
6101A-1026	8	200	327	1.2	8	165	155
6101A-1028	10	250	377	1.6	9	185	175

**No.6103 Injection Electrician Screwdriver**



Number	L <sub>1</sub> inch	L <sub>1</sub> mm	L mm	H mm	B mm	Be-Cu g	Al-Cu g
6103-1002	2	50	134	0.4	3	37	35
6103-1004	3	75	159	0.6	4	47	45
6103-1006	4	100	205	0.8	5	95	90
6103-1008	6	150	265	0.8	6	145	135
6103-1010	8	200	327	1.0	8	230	210

**No.6201 Injection Pliers, Lineman**



Number	Size inch	L mm	Be-Cu g	Al-Cu g
6201-1002	6	150	180	165
6201-1004	7	175	355	330
6201-1006	8	200	465	435

**No.6201A Dipped Pliers, Lineman**



Number	Size inch	L mm	Be-Cu g	Al-Cu g
6201A-1002	6	150	180	165
6201A-1004	7	175	355	330
6201A-1006	8	200	465	435

**No.6202 Injection Pliers, Snipe Nose**



Number	Size inch	L mm	L <sup>1</sup> mm	Be-Cu g	Al-Cu g
6202-1002	6	150	54	190	170
6202-1004	8	200	74	335	300

**No.6202A Dipped Pliers, Snipe Nose**



Number	Size inch	L mm	L <sup>1</sup> mm	Be-Cu g	Al-Cu g
6202A-1002	6	150	54	190	170
6202A-1004	8	200	74	335	300

**No.6203 Injection Pliers, Diagonal Cutting**



Number	Size inch	L mm	Be-Cu g	Al-Cu g
6203-1002	6	150	245	225
6203-1004	8	200	410	365

**No.6203A Dipped Pliers, Diagonal Cutting**

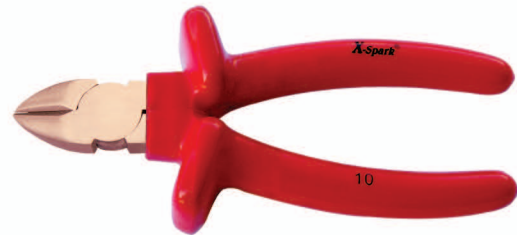

Number	Size inch	L mm	Be-Cu g	Al-Cu g
6203A-1002	6	150	245	225
6203A-1004	8	200	410	365

**No.6204 Injection Pliers, Round 45 Degree Bent**



Number	Size inch	L mm	Be-Cu g	Al-Cu g
6204-1002	6	150	190	170

**No.6204A Dipped Pliers, Round 45 Degree Bent**



Number	Size inch	L mm	Be-Cu g	Al-Cu g
6204A-1002	6	150	190	170

**No.6205 Injection Pliers, Flat Nose**



Number	Size inch	L mm	Be-Cu g	Al-Cu g
6205-1002	6	150	165	151
6205-1004	8	200	281	257

**No.6205A Dipped Pliers, Flat Nose**



Number	Size inch	L mm	Be-Cu g	Al-Cu g
6205A-1002	6	150	165	151
6205A-1004	8	200	281	257

**No.6206 Injection Pliers, Round Nose**



Number	Size inch	L mm	Be-Cu g	Al-Cu g
6206-1002	6	150	165	150

**No.6206A Dipped Pliers, Round Nose**

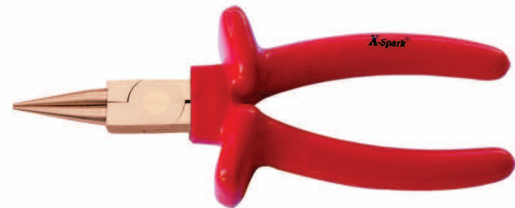

Number	Size inch	L mm	Be-Cu g	Al-Cu g
6206A-1002	6	150	165	150

**No.6207 Injection Wire Stripping Pliers**



Number	L mm	Be-Cu g	Al-Cu g
6207-1002	170	225	205

**No.6207A Dipped Wire Stripping Pliers**

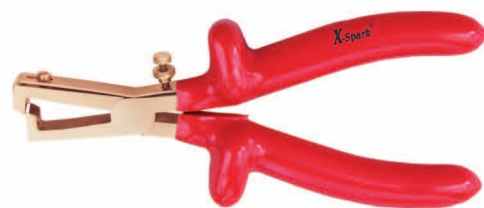

Number	L mm	Be-Cu g	Al-Cu g
6207A-1002	170	225	205

**No.6208 Dipped Pliers, Slip Joint**



Number	Size inch	L mm	K <sub>max</sub> mm	Be-Cu g	Al-Cu g
6208-1002	10	250	32	365	335

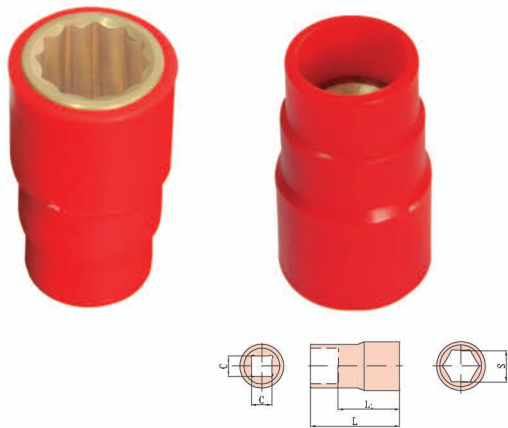

**No.6301 Injection Socket (C≅3/8")**

Number	S mm	L <sub>1</sub> mm	L mm	Be-Cu g	Al-Cu g
6301-8	8	28	44	35	32
6301-9	9	28	44	35	32
6301-10	10	32	48	50	45
6301-11	11	32	48	50	45
6301-12	12	32	48	50	45
6301-13	13	32	48	50	45
6301-14	14	32	48	50	45
6301-15	15	32	48	53	48
6301-16	16	32	48	58	53
6301-17	17	32	48	63	57
6301-19	19	32	48	68	62
6301-20	20	32	48	77	70

**No.6302 Injection Socket (C≅1/2")**

Number	S mm	L <sub>1</sub> mm	L mm	Be-Cu g	Al-Cu g
6302-10	10	40	56	78	71
6302-11	11	40	56	79	72
6302-12	12	40	56	79	72
6302-13	13	40	56	80	73
6302-14	14	40	56	80	73
6302-15	15	40	56	94	85
6302-16	16	40	56	94	85
6302-17	17	40	56	94	85
6302-18	18	42	58	94	85
6302-19	19	42	58	110	100
6302-20	20	42	58	120	105
6302-21	21	43	59	125	110
6302-22	22	43	59	130	115
6302-23	23	43	59	150	135
6302-24	24	43	59	165	145
6302-25	25	43	59	180	160
6302-26	26	43	59	200	180
6302-27	27	46	62	215	190
6302-28	28	46	62	225	200
6302-29	29	46	62	235	210
6302-30	30	46	62	250	220
6302-32	32	46	62	295	260

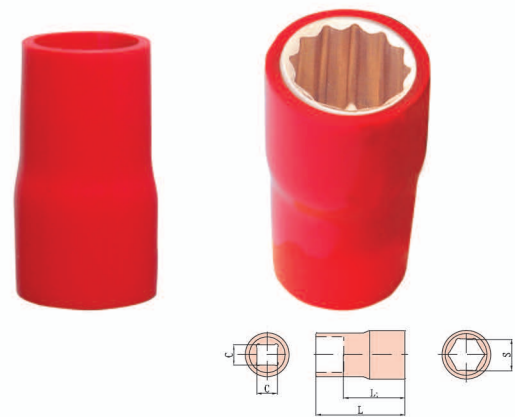

**No.6301A Dipped Socket (C≅3/8")**

Number	S mm	L <sub>1</sub> mm	L mm	Be-Cu g	Al-Cu g
6301A-8	8	28	44	35	32
6301A-9	9	28	44	35	32
6301A-10	10	32	48	50	45
6301A-11	11	32	48	50	45
6301A-12	12	32	48	50	45
6301A-13	13	32	48	50	45
6301A-14	14	32	48	50	45
6301A-15	15	32	48	53	48
6301A-16	16	32	48	58	53
6301A-17	17	32	48	63	57
6301A-19	19	32	48	68	62
6301A-20	20	32	48	77	70

**No.6302A Dipped Socket (C≅1/2")**

Number	S mm	L <sub>1</sub> mm	L mm	Be-Cu g	Al-Cu g
6302A-10	10	40	56	78	71
6302A-11	11	40	56	79	72
6302A-12	12	40	56	79	72
6302A-13	13	40	56	80	73
6302A-14	14	40	56	80	73
6302A-15	15	40	56	94	85
6302A-16	16	40	56	94	85
6302A-17	17	40	56	94	85
6302A-18	18	42	58	94	85
6302A-19	19	42	58	110	100
6302A-20	20	42	58	120	105
6302A-21	21	43	59	125	110
6302A-22	22	43	59	130	115
6302A-23	23	43	59	150	135
6302A-24	24	43	59	165	145
6302A-25	25	43	59	180	160
6302A-26	26	43	59	200	180
6302A-27	27	46	62	215	190
6302A-28	28	46	62	225	200
6302A-29	29	46	62	235	210
6302A-30	30	46	62	250	220
6302A-32	32	46	62	295	260

### No.6303 Injection Sliding T Type Wrench



Number	C inch	L mm	H mm	Be-Cu g	Al-Cu g
6303-1002	3/8	140	200	360	330
6303-1004	1/2	140	200	440	400

### No.6303A Dipped Sliding T Type Wrench



Number	C inch	L mm	H mm	Be-Cu g	Al-Cu g
6303A-1002	3/8	140	200	370	340
6303A-1004	1/2	140	200	465	420

### No.6304 Dipped Driver Extension

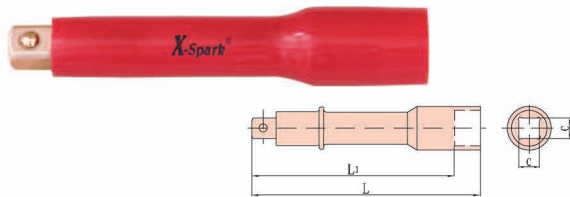

Number	C inch	L <sub>1</sub> mm	L mm	Be-Cu g	Al-Cu g
6304-1002	3/8	75	91	93	80
6304-1004	3/8	150	166	185	160
6304-1006	1/2	125	141	260	230
6304-1008	1/2	250	266	470	425

### No.6306 Dipped Sliding T Type Wrench



Number	S mm	L mm	H mm	Be-Cu g	Al-Cu g
6306-7	7	120	120	100	90
6306-9	9	130	130	155	140
6306-11	11	140	150	190	170
6306-14	14	150	170	265	240
6306-17	17	170	190	410	370
6306-19	19	180	210	535	480

### No.6305 Dipped Sliding T Handle



Number	C inch	L mm	H mm	Be-Cu g	Al-Cu g
6305-1002	1/2	250	39	340	310
6305-1004	3/8	160	37	135	120

### No.6307 Dipped Offset Handle



Number	C inch	L mm	H mm	Be-Cu g	Al-Cu g
6307-1002	3/8	200	50	314	287
6307-1004	1/2	230	60	410	380

### No.6308 Dipped Internal Hexagon Socket



Number	C inch	S mm	L <sub>1</sub> mm	L mm	Be-Cu g	Al-Cu g
6308-3	1/4	3	55	71	17	16
6308-4		4	55	71	17	16
6308-5		5	55	71	20	18
6308-6		6	55	71	26	23
6308-7		7	55	71	30	27
6308-8		8	65	81	45	40
6308-9		9	65	81	55	50
6308-10		10	65	81	65	60

**No.6401 Injection Wrench, Single Open End**



Number	S mm	L mm	Be-Cu g	Al-Cu g
6401-8	8	95	40	35
6401-10	10	100	50	45
6401-12	12	110	65	60
6401-14	14	140	95	85
6401-17	17	160	105	95
6401-19	19	170	130	115
6401-22	22	195	170	152
6401-24	24	220	190	170
6401-27	27	240	285	260
6401-30	30	260	320	290
6401-32	32	275	400	365

**No.6401B Injection Wrench, Single Open End**



Number	S mm	L mm	Be-Cu g	Al-Cu g
6401B-8	8	95	40	35
6401B-10	10	100	50	45
6401B-12	12	110	65	60
6401B-14	14	140	95	85
6401B-17	17	160	105	95
6401B-19	19	170	130	115
6401B-22	22	195	170	152
6401B-24	24	220	190	170
6401B-27	27	240	285	260
6401B-30	30	260	320	290
6401B-32	32	275	400	365

**No.6401A Dipped Wrench, Single Open End**



Number	S mm	L mm	Be-Cu g	Al-Cu g
6401A-8	8	95	40	35
6401A-10	10	100	50	45
6401A-12	12	110	65	60
6401A-14	14	140	95	85
6401A-17	17	160	105	95
6401A-19	19	170	130	115
6401A-22	22	195	170	152
6401A-24	24	220	190	170
6401A-27	27	240	285	260
6401A-30	30	260	320	290
6401A-32	32	275	400	365

**No.6403 Dipped Wrench, Single Box**



Number	S mm	L mm	Be-Cu g	Al-Cu g
6403-8	8	110	40	35
6403-10	10	120	50	45
6403-12	12	130	65	60
6403-14	14	140	90	80
6403-17	17	155	105	90
6403-19	19	170	130	95
6403-22	22	190	175	150
6403-24	24	215	220	200
6403-27	27	230	270	245
6403-30	30	255	370	335
6403-32	32	265	425	385

**No.6402 Injection Wrench, Adjustable**



Number	L mm	K <sub>max</sub> mm	Be-Cu g	Al-Cu g
6402-1002	150	18	135	120
6402-1004	200	24	281	255
6402-1006	250	30	440	401
6402-1008	300	36	720	655

**No.6402A Dipped Wrench, Adjustable**



Number	L mm	K <sub>max</sub> mm	Be-Cu g	Al-Cu g
6402A-1002	150	18	135	120
6402A-1004	200	24	281	255
6402A-1006	250	30	440	401
6402A-1008	300	36	720	655

**No.6404 Dipped Wrench, Single Box Offset**



Number	S mm	L mm	Be-Cu g	Al-Cu g
6404-10	10	125	66	60
6404-12	12	130	88	80
6404-14	14	145	120	110
6404-17	17	155	145	130
6404-19	19	170	165	150
6404-22	22	190	185	165
6404-24	24	215	235	210
6404-27	27	230	310	270
6404-30	30	255	430	380
6404-32	32	265	450	400

**No.6406 Dipped Ratchet Wrench**



Number	S <sub>1</sub> mm	S <sub>2</sub> mm	L mm	Be-Cu g	Al-Cu g
6406-1417	14	17	280	410	370
6406-1719	17	19	310	450	410
6406-1922	19	22	345	530	480
6406-2224	22	24	365	680	620

**No.6405 Dipped Wrench, Hex Key**



Number	S mm	L mm	H mm	Be-Cu g	Al-Cu g
6405-3	3	59	25	8	7
6405-4	4	65	30	10	8
6405-5	5	79	32	16	12
6405-6	6	85	37	25	20
6405-7	7	88	43	34	30
6405-8	8	92	44	50	45
6405-9	9	97	44	61	55
6405-10	10	110	45	82	70
6405-11	11	119	48	100	90
6405-12	12	130	52	145	130

**No.6501 Insulated Tools Set-24pcs**



L\*W\*H:435\*400\*150mm  
 AL-CU: G.W.: 4750g N.W.: 2900g  
 BE-CU: G.W.: 5040g N.W.: 3190g

Tools	Description
Wrench Single Open End	10, 11, 12, 13, 14, 17, 19mm
Pliers Lineman	8 "
Pliers Diagonal Cutting	6 "
Screwdriver Slotted	3*50, 4*100, 5*100mm
Screwdriver Phillips	#0*50, #1*75, #2*150 #1*100 mm
Socket 1/2 "	10, 11, 12, 13, 14, 17, 19mm
Sliding T Type Wrench	1/2 "

**No.6601 Dipped Hammer, Ball Pein**



Number	S g	L mm	Weight g
6601-1002	230	280	403
6601-1004	340	280	502
6601-1006	450	310	680
6601-1008	680	340	950
6601-1010	910	350	1205
6601-1012	1130	400	1470



# Insulated Tools

M



1000V

MANUFACTURED  
ACCORDING TO  
**IEC60900**  
STANDARD



**No.7101 Injection Slotted Screwdriver**



Number	L <sub>1</sub> inch	L <sub>1</sub> mm	L mm	H mm	B mm	 g
7101-1002	2	50	134	0.5	3	35
7101-1006	3	75	159	0.6	3	34
7101-1008	3	75	159	0.8	4	44
7101-1010	3	75	180	1.0	5	68
7101-1012	4	100	184	0.8	4	44
7101-1014	4	100	205	1.0	5	73
7101-1016	4	100	215	1.1	6	84
7101-1018	5	125	240	1.1	6	100
7101-1020	6	150	265	1.1	6	110
7101-1022	6	150	265	1.2	7	125
7101-1024	6	150	277	1.2	8	140
7101-1026	8	200	327	1.2	8	165
7101-1028	10	250	377	1.6	9	185

**No.7101A Injection Slotted Screwdriver**



Number	L <sub>1</sub> inch	L <sub>1</sub> mm	L mm	H mm	B mm	 g
7101A-1002	2	50	134	0.5	3	35
7101A-1006	3	75	159	0.6	3	34
7101A-1008	3	75	159	0.8	4	44
7101A-1010	3	75	180	1.0	5	68
7101A-1012	4	100	184	0.8	4	44
7101A-1014	4	100	205	1.0	5	73
7101A-1016	4	100	215	1.1	6	84
7101A-1018	5	125	240	1.1	6	100
7101A-1020	6	150	265	1.1	6	110
7101A-1022	6	150	265	1.2	7	125
7101A-1024	6	150	277	1.2	8	140
7101A-1026	8	200	327	1.2	8	165
7101A-1028	10	250	377	1.6	9	185

**No.7102 Injection Phillips Screwdriver**



Number	L <sub>1</sub> inch	size	L <sub>1</sub> mm	L mm	Φ mm	 g
7102-1002	2	0	50	134	3	34
7102-1004	3	1	75	159	4	66
7102-1006	4	1	100	205	5	73
7102-1008	5	2	125	240	6	100
7102-1010	6	2	150	265	6	110
7102-1012	8	3	200	327	8	165
7102-1014	10	3	250	377	8	180

**No.7102A Injection Phillips Screwdriver**



Number	L <sub>1</sub> inch	size	L <sub>1</sub> mm	L mm	Φ mm	 g
7102A-1002	2	0	50	134	3	34
7102A-1004	3	1	75	159	4	66
7102A-1006	4	1	100	205	5	73
7102A-1008	5	2	125	240	6	100
7102A-1010	6	2	150	265	6	110
7102A-1012	8	3	200	327	8	165
7102A-1014	10	3	250	377	8	180

**No.7103 Injection Electrician Screwdriver**



Number	L <sub>1</sub> inch	L <sub>1</sub> mm	L mm	H mm	B mm	 g
7103-1002	2	50	134	0.4	3	37
7103-1004	3	75	153	0.6	4	47
7103-1006	4	100	205	0.8	5	95
7103-1008	6	150	265	0.8	6	145
7103-1010	8	200	327	1.0	8	230

**No.7201 Injection Pliers, Lineman**



Number	Size inch	L mm	 g
7201-1002	6	150	175
7201-1004	7	175	350
7201-1006	8	200	455

**No.7201A Dipped Pliers, Lineman**



Number	Size inch	L mm	 g
7201A-1002	6	150	173
7201A-1004	7	175	345
7201A-1006	8	200	455

**No.7202 Injection Pliers, Snipe Nose**

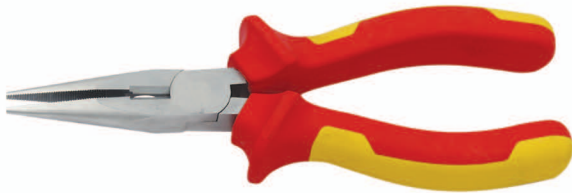

Number	Size inch	L mm	L <sup>1</sup> mm	 g
7202-1002	6	150	54	180
7202-1004	8	200	74	315

**No.7202A Dipped Pliers, Snipe Nose**



Number	Size inch	L mm	L <sup>1</sup> mm	 g
7202A-1002	6	150	54	180
7202A-1004	8	200	74	315

**No.7203 Pliers, Diagonal Cutting**



Number	Size inch	L mm	 g
7203-1002	6	150	235
7203-1004	8	200	385

**No.7203A Dipped Pliers, Diagonal Cutting**



Number	Size inch	L mm	 g
7203A-1002	6	150	235
7203A-1004	8	200	385

**No.7204 Injection Pliers, Round 45 Degree Bent**



Number	Size inch	L mm	 g
7204-1002	6	150	180

**No.7204A Dipped Pliers, Round 45 Degree Bent**

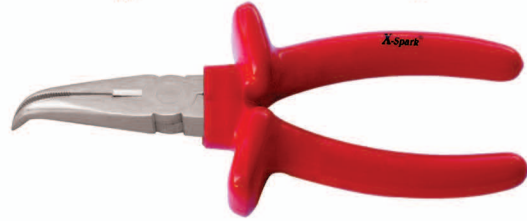

Number	Size inch	L mm	 g
7204A-1002	6	150	180

**No.7205 Injection Pliers, Flat Nose**



Number	Size inch	L mm	 g
7205-1002	6	150	155
7205-1004	8	200	270

**No.7205A Dipped Pliers, Flat Nose**



Number	Size inch	L mm	 g
7205A-1002	6	150	155
7205A-1004	8	200	270

**No.7206 Injection Pliers, Round Nose**



Number	Size inch	L mm	 g
7206-1002	6	150	155

**No.7206A Dipped Pliers, Round Nose**



Number	Size inch	L mm	 g
7206A-1002	6	150	155

**No.7207 Injection Wire Stripping Pliers**



Number	L mm	 g
7207-1002	160	215

**No.7207A Dipped Wire Stripping Pliers**



Number	L mm	 g
7207A-1002	160	215

**No.7208 Dipped Pliers, Slip Joint**



Number	Size inch	L mm	K <sub>max</sub> mm	g
7208-1002	10	250	32	350

**No.7208A Injection Pliers, Slip Joint**



Number	Size inch	L mm	K <sub>max</sub> mm	g
7208A-1002	10	250	32	350

**No.7209 Cable Pliers**



Number	L mm	g
7209-1002	250	500

**No.7210 Injection Bent Pliers, Lineman**



Number	L mm	g
7210-1002	175	285

**No.7209A Ratchet Cable Cutter**



Number	Size inch	L mm	g
7209A-1002	9	230	560

**No.7211 Injection Bent Pliers, Snipe Nose**



Number	L mm	g
7211-1002	215	290

**No.7212 Injection Bent Pliers, Diagonal Cutting**



Number	L mm	g
7212-1002	175	265



**No.7301 Injection Socket ( C≡3/8<sup>u</sup>)**

Number	S mm	L <sub>1</sub> mm	L mm	g
7301-8	8	28	44	34
7301-9	9	28	44	34
7301-10	10	28	44	47
7301-11	11	28	44	47
7301-12	12	28	44	47
7301-13	13	28	44	47
7301-14	14	28	44	47
7301-15	15	28	44	50
7301-16	16	28	44	55
7301-17	17	30	46	60
7301-19	19	30	46	65
7301-20	20	32	48	75

**No.7302 Injection Socket ( C≡1/2<sup>u</sup>)**

Number	S mm	L <sub>1</sub> mm	L mm	g
7302-10	10	38	55	75
7302-11	11	38	55	75
7302-12	12	38	55	75
7302-13	13	38	55	77
7302-14	14	38	55	77
7302-15	15	38	55	90
7302-16	16	38	55	90
7302-17	17	38	55	90
7302-18	18	38	55	90
7302-19	19	38	55	105
7302-20	20	38	55	110
7302-21	21	38	55	115
7302-22	22	38	55	120
7302-23	23	38	55	142
7302-24	24	38	55	155
7302-25	25	41	58	170
7302-26	26	41	58	190
7302-27	27	42	59	200
7302-28	28	44	61	210
7302-29	29	44	61	225
7302-30	30	44	61	235
7302-32	32	44	61	275

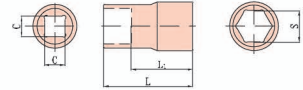

**No.7301A Dipped Socket ( C≡3/8<sup>u</sup>)**

Number	S mm	L <sub>1</sub> mm	L mm	g
7301A-8	8	28	44	34
7301A-9	9	28	44	34
7301A-10	10	28	44	47
7301A-11	11	28	44	47
7301A-12	12	28	44	47
7301A-13	13	28	44	47
7301A-14	14	28	44	47
7301A-15	15	28	44	50
7301A-16	16	28	44	55
7301A-17	17	30	46	60
7301A-19	19	30	46	65
7301A-20	20	32	48	75

**No.7302A Dipped Socket ( C≡1/2<sup>u</sup>)**

Number	S mm	L <sub>1</sub> mm	L mm	g
7302A-10	10	38	55	75
7302A-11	11	38	55	75
7302A-12	12	38	55	75
7302A-13	13	38	55	77
7302A-14	14	38	55	77
7302A-15	15	38	55	90
7302A-16	16	38	55	90
7302A-17	17	38	55	90
7302A-18	18	38	55	90
7302A-19	19	38	55	105
7302A-20	20	38	55	110
7302A-21	21	38	55	115
7302A-22	22	38	55	120
7302A-23	23	38	55	142
7302A-24	24	38	55	155
7302A-25	25	41	58	170
7302A-26	26	41	58	190
7302A-27	27	42	59	200
7302A-28	28	44	61	210
7302A-29	29	44	61	225
7302A-30	30	44	61	235
7302A-32	32	44	61	275

**No.7303 Injection Sliding T Type Wrench**



Number	C inch	L mm	H mm	g
7303-1002	3/8	140	200	350
7303-1004	1/2	140	200	420

**No.7303A Dipped Sliding T Type Wrench**



Number	C inch	L mm	H mm	g
7303A-1002	3/8	140	200	350
7303A-1004	1/2	140	200	420

**No.7304 Dipped Driver Extension**

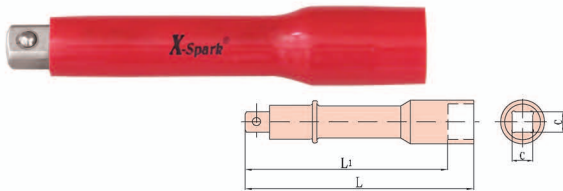

Number	C inch	L <sub>1</sub> mm	L mm	g
7304-1002	3/8	75	91	85
7304-1004	3/8	150	166	170
7304-1006	1/2	125	141	245
7304-1008	1/2	250	266	450

**No.7304A Injection Driver Extension**



Number	C inch	L <sub>1</sub> mm	L mm	g
7304A-1002	3/8	75	91	85
7304A-1004	3/8	150	166	170
7304A-1006	1/2	125	141	245
7304A-1008	1/2	250	266	450

**No.7306 Dipped Sliding T Type Wrench**



Number	S mm	L mm	H mm	g
7306-7	7	120	120	95
7306-9	9	130	130	150
7306-11	11	140	150	180
7306-14	14	150	170	255
7306-17	17	170	190	390
7306-19	19	180	210	510

**No.7305 Dipped Sliding T Handle**



Number	C inch	L mm	g
7305-1002	1/2	250	325
7305-1004	3/8	160	125

**No.7307 Dipped Offset Handle**



Number	C inch	L mm	g
7307-1002	3/8	200	305
7307-1004	1/2	230	410

## No.7401 Injection Wrench, Single Open End



Number	S mm	L mm	g
7401-8	8	95	40
7401-10	10	100	50
7401-12	12	110	65
7401-14	14	140	90
7401-17	17	160	100
7401-19	19	170	120
7401-22	22	195	160
7401-24	24	220	180
7401-27	27	240	270
7401-30	30	260	300
7401-32	32	275	380

## No.7308 Dipped Internal Hexagon Socket

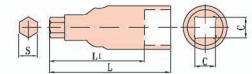

Number	C inch	S mm	L <sub>1</sub> mm	L mm	g
7308-3	1/4	3	55	71	17
7308-4		4	55	71	17
7308-5		5	55	71	20
7308-6		6	55	71	25
7308-7		7	55	71	30
7308-8		8	65	81	45
7308-9		9	65	81	55
7308-10		10	65	81	65

## No.7401B Injection Wrench, Single Open End

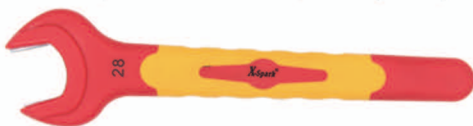

Number	S mm	L mm	g
7401B-8	8	95	40
7401B-10	10	100	50
7401B-12	12	110	65
7401B-14	14	140	90
7401B-17	17	160	100
7401B-19	19	170	120
7401B-22	22	195	160
7401B-24	24	220	180
7401B-27	27	240	270
7401B-30	30	260	300
7401B-32	32	275	380

## No.7401A Dipped Wrench, Single Open End



Number	S mm	L mm	g
7401A-8	8	95	40
7401A-10	10	100	50
7401A-12	12	110	65
7401A-14	14	140	90
7401A-17	17	160	100
7401A-19	19	170	120
7401A-22	22	195	160
7401A-24	24	220	180
7401A-27	27	240	270
7401A-30	30	260	300
7401A-32	32	275	380

## No.7402 Injection Wrench, Adjustable



Number	L mm	K <sub>max</sub> mm	g
7402-1002	150	18	125
7402-1004	200	24	270
7402-1006	250	30	420
7402-1008	300	36	690

## No.7402A Dipped Wrench, Adjustable



Number	L mm	K <sub>max</sub> mm	g
7402A-1002	150	18	125
7402A-1004	200	24	270
7402A-1006	250	30	420
7402A-1008	300	36	690



**No.7402B Insulated plastic impregnated spanner**



Number	Size mm	K <sub>max</sub> mm	g
7402B-1002	150	20	240
7402B-1004	200	25	410
7402B-1006	250	30	720
7402B-1008	300	40	1000
7402B-1010	350	50	1390
7402B-1012	450	60	2160
7402B-1014	600	75	3500
7402B-1016	900	85	6000

**No.7403 Dipped Wrench, Single Box**



Number	S mm	L mm	g
7403-8	8	110	40
7403-10	10	120	50
7403-12	12	130	65
7403-14	14	140	85
7403-17	17	155	95
7403-19	19	170	100
7403-22	22	190	160
7403-24	24	215	210
7403-27	27	230	255
7403-30	30	255	355
7403-32	32	265	405

**No.7404 Dipped Wrench, Single Box Offset**



Number	S mm	L mm	g
7404-10	10	125	65
7404-12	12	130	85
7404-14	14	145	115
7404-17	17	155	140
7404-19	19	170	160
7404-22	22	190	175
7404-24	24	215	220
7404-27	27	230	285
7404-30	30	255	400
7404-32	32	265	420

**No.7404A Injection Wrench, Single Box Offset**



Number	S mm	L mm	g
7404A-10	10	182	65
7404A-12	12	195	85
7404A-14	14	200	115
7404A-17	17	220	140
7404A-19	19	232	160
7404A-22	22	252	175
7404A-24	24	290	220
7404A-27	27	300	285
7404A-30	30	315	400
7404A-32	32	330	420

**No.7405 Dipped Wrench, Hex Key**



Number	S mm	L mm	H mm	g
7405-3	3	59	25	7
7405-4	4	65	30	8
7405-5	5	79	32	12
7405-6	6	85	37	20
7405-7	7	88	43	30
7405-8	8	92	44	50
7405-9	9	97	44	60
7405-10	10	110	45	75
7405-11	11	119	48	95
7405-12	12	130	52	140

**No.7406 Dipped Ratchet Wrench**



Number	S <sub>1</sub> mm	S <sub>2</sub> mm	L mm	g
7406-1417	14	17	280	390
7406-1719	17	19	310	435
7406-1922	19	22	345	505
7406-2224	22	24	365	655

**No.7407 Injection Ratchet Wrench**



Number	C inch	L mm	g
7407-1002	1/2	250	215

**No.7407A Dipped Ratchet Wrench**



Number	C inch	L mm	g
7407A-1002	1/2	250	215

**No.7601 Dipped Hacksaw**



Number	Size	L mm	g
7601-1002	300	470	825

**No.7602 Dipped Tweezers**



Number	L inch	L mm	g
7602-1002	6	150	45

**No.7603 Injection Scissors**



Number	L mm	g
7603-1002	150	100

**No.7604 Injection Knife**



Number	Size	g
7604-1002	50*180	85

## No.7605 Insulated Tape



Number	Size	 g
7605-1002	20mm*10m	85

## No.7606 Test Pencil



Number	Insulation V	L mm	 g
7606-1002	12-250	140	25

## No.7607 Dipped Chisel 6 point



Number	S mm	L mm	B mm	 g
7607-1002	10	150	12	96
7607-1004	14	200	16	271
7607-1006	16	160	18	282
7607-1008	14	250	16	342
7607-1010	17	300	19	741
7607-1012	17	350	19	861
7607-1014	22	600	24	1742
7607-1016	25	300	28	1130
7607-1018	30	500	35	2660

## No.7501 Insulated Tools Set - 24 pcs



L\*W\*H:  
400\*290\*90mm

Tools	Description
Wrench, Single Open End	10, 11, 12, 13, 14, 17, 19mm
Pliers, Lineman	8 "
Pliers, Diagonal Cutting	6 "
Slotted Screwdriver	3*50, 4*100, 5*100mm
Phillips Screwdriver	#0*50, #1*75, #2*150 #1*100mm
Socket 1/2 "	10, 11, 12, 13, 14, 17, 19mm
Sliding T Type Wrench	1/2 "

## No.7502 Insulated Tools Set - 7 pcs



Tools	Description
Pliers, Lineman	200mm
Pliers, Diagonal Cutting	160mm
Pliers, Snipe Nose	200mm
Wire Stripping Pliers	160mm
Slotted Screwdriver	4*100mm
Phillips Screwdriver	#1*75mm
Test Pencil	150mm

## No.7503 Insulated Tools Set - 8 pcs



Tools	Description
Pliers, Lineman	200mm
Pliers, Diagonal Cutting	150mm
Pliers, Snipe Nose	200mm
Slotted Screwdriver	4*100mm, 6*150mm
Phillips Screwdriver	#1*75mm, #2*150mm
Test Pencil	150mm

**No.7504 Insulated Tools Set - 41 pcs**



Tools	Description
Pliers, Lineman	200mm
Pliers, Diagonal Cutting	160mm
Cable Cutter	250mm
Wire Stripping Pliers	160mm
Slotted Screwdriver	3*75, 4*100, 5*125, 6*150mm
Phillips Screwdriver	#1*75, #2*100mm
Single Open End	10, 13, 14, 17, 19, 22mm
Single Box	10, 13, 14, 17, 19, 22mm
Wrench, Adjustable	250mm
Ratchet Wrench	1/2"
Sliding T Type Wrench	1/2"
Driver Extension	1/2" *125mm, 1/2" *250mm
Socket 1/2"	10, 11, 12, 13, 14, 16, 17, 18, 19, 22, 24mm
Electrician Knife	50*180mm
Shears, Cutting	160mm
Insulating Tape	20mm*10m

**No.7505 Insulated Tools Set - 43 pcs**



Tools	Description
Pliers, Lineman	200mm
Pliers, Diagonal Cutting	160mm
Wire Stripping Pliers	160mm
Cable Cutter	250mm
Pliers, Water Pump	250mm
Single Open End	10, 13, 14, 17, 19, 22mm
Single Box	10, 13, 14, 17, 19, 22mm
Wrench, Adjustable	250mm
Slotted Screwdriver	3*75, 4*100mm, 5*125, 6*150mm
Ratchet Wrench	1/2"
Sliding T Type Wrench	1/2"
Driver Extension	1/2" *125mm, 1/2" *250mm
Socket 1/2"	10, 11, 12, 13, 14, 17, 19, 22, 24mm
Cable Knife	180mm
Knife	160mm
Insulating Clamp	6pcs
Insulating Mat	3pcs

**No.7506 Insulated Tools Set - 11 pcs**



Tools	Description
Slotted Screwdriver	3*50mm, 4*75mm, 5*100mm, 6*125mm, 6*150mm
Phillips Screwdriver	3*50mm, 4*75mm, 5*100mm, 6*125mm, 6*150mm

**No.7507 Insulated Tools Set - 11 pcs**



Tools	Description
Socket 1/2 "	10mm, 11mm, 12mm, 14mm, 17mm, 19mm, 22mm, 27mm,
Sliding T Type Wrench	1/2 "
Offset Handle	1/2 "